

# FREQUENCY COUNTER

## 5382A

### OPERATING AND SERVICE MANUAL

**SERIAL PREFIX: 1804A**

This manual applies directly to HP Model 5382A Frequency Counters having the above serial number prefix.

#### NEWER INSTRUMENTS

This manual, with enclosed "Manual Changes" sheet, applies to HP Model 5382A Frequency Counters having serial number prefixes as listed on the "Manual Changes" sheet.

#### OLDER INSTRUMENTS

For serial prefixes below the serial prefix shown above, refer to Section VII for manual backdating instructions.

Copyright      HEWLETT-PACKARD COMPANY      1974  
5301 STEVENS CREEK BLVD., SANTA CLARA, CALIF. 95050

MANUAL PART NUMBER 05382-90008  
MICROFICHE PART NUMBER 05382-90009

Printed: APRIL 1978



**HEWLETT  
PACKARD**

## CERTIFICATION

*The Hewlett-Packard Company certifies that this instrument was thoroughly tested and inspected and found to meet its published specifications when it was shipped from the factory. The Hewlett-Packard Company further certifies that its calibration measurements are traceable to the U.S. National Bureau of Standards to the extent allowed by the Bureau's calibration facility.*

## WARRANTY AND ASSISTANCE

This Hewlett-Packard product is warranted against defects in materials and workmanship. This warranty applies for one year from the date of delivery, or, in the case of certain major components listed in the manual, for the specified period. We will repair or replace products which prove to be defective during the warranty period provided they are returned to Hewlett-Packard. No other warranty is expressed or implied. We are not liable for consequential damages.

Service contracts or customer assistance agreements are available for Hewlett-Packard products that require maintenance and repair on-site.

For any assistance, contact your nearest Hewlett-Packard Sales and Service Office.

Model 5382A  
General Information

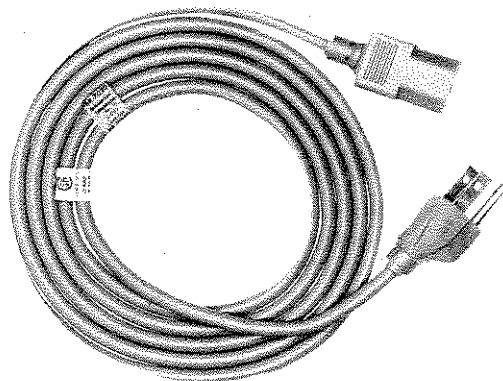
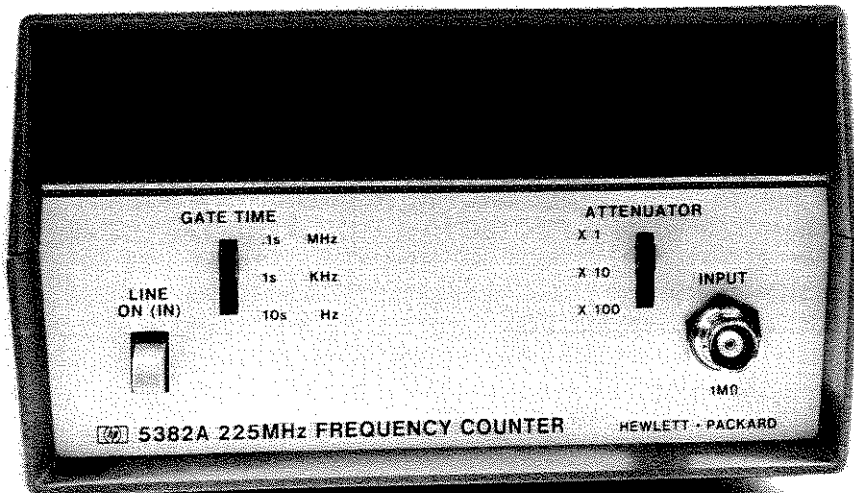

**CORD SET 8120-1378**

**Figure 1-1. Model 5382A and Equipment Supplied**

## SECTION I

### GENERAL INFORMATION

#### 1-1. INTRODUCTION

1-2. This section of the manual gives a description of the instrument, information on instrument identification and available options, and complete specifications.

#### 1-3. INSTRUMENT DESCRIPTION

1-4. The HP Model 5382A Frequency Counter (see Figure 1-1) is a direct-counting frequency counter that has a range of 10 Hz to 225 MHz. Eight display digits are provided. Front-panel controls allow a selection of gate times and attenuation factors of the input signal. A rear-panel connector and associated selector switch allow connection of an external time base oscillator or monitoring of the internal time base oscillator. This feature also allows ratio measurements to be made by the counter. When the optional temperature compensated crystal oscillator is included (Option 001), the switch is not provided and the connector is used to monitor the 10 MHz time base oscillator. Refer to Table 1-1 for all counter specifications.

#### 1-5. ACCESSORIES AND OPTIONS

1-6. Two accessories are available for mounting the 5382A counter onto the user's rack. The 10851A kit permits the mounting of a single counter, while the 10852A kit is used for mounting two counters in a side-by-side configuration. Refer to Section II for detailed rack mounting kit information.

1-7. Option 001 provides a more accurate and stable time base oscillator. This Temperature Compensated Crystal Oscillator (TCXO) installation modifies the rear panel so that the connector is used only as a MONITOR output. As a result, an external standard (i.e., time base) cannot be applied to the Option 001 counter.

#### 1-8. INSTRUMENT IDENTIFICATION

1-9. Hewlett-Packard uses a 2-section, 10-character serial number (0000A00000) mounted on the rear panel to identify the instrument. The first four digits are the serial prefix and the last five digits refer to the specific instrument. The alphabetical character identifies the country of manufacture. If the serial prefix on your instrument differs from that listed on the title page of this manual, there are differences between the manual and your instrument. Any lower serial prefixes are documented separately in this manual, and higher serial prefixes are covered by a manual change sheet included with the manual.

1-10. The printed circuit boards within the instrument are identified by a 2-section, 10-digit part number (e.g., 05382-60004) and a 4-digit series number (e.g., "SERIES 1804"). The series number identifies the electrical characteristics of the complete printed-circuit assembly. A replacement circuit-board assembly may have a different series number than the assembly originally supplied with the instrument. Therefore, when troubleshooting a circuit-board assembly, ensure that the series number on the schematic diagram matches the series number on the board assembly. If the series number of the assembly is lower than the number on the schematic diagram in Section IX, refer to backdating information in this manual for change information. If the series number on the assembly is higher than the number on the schematic diagram, the change information is provided in a manual change sheet which is available from the nearest Hewlett-Packard Sales and Service Office.

**1-11. MICROFICHE NUMBER**

1-12. On the title page of this manual, below the manual part number, is the microfiche part number. This number may be used to order 4 x 6 transparencies of the manual. The microfiche package also includes the latest Manual Change Supplements as well as all pertinent Service Notes.

**1-13. RECOMMENDED TEST EQUIPMENT**

1-14. Table 4-1 lists test equipment which is recommended for confirming instrument specifications (i.e., in-cabinet performance tests), as well as troubleshooting and adjusting the instrument.

**1-15. SPECIFICATIONS**

1-16. Table 1-1 lists the 5382A specifications.

**Table 1-1. Specifications**

<p><b>Frequency Range:</b> 10 Hz to 225 MHz  <b>Sensitivity:</b> 25 mV rms - 30 Hz to 10 MHz                            50 mV rms - 10 Hz to 225 MHz  <b>Input Impedance:</b> 1 MΩ, &lt; 40 pF  <b>Accuracy:</b> ±1 count ± timebase error  <b>Resolution:</b> Direct count: 1 Hz in 1 second  <b>Gate Time:</b> 0.1 second, 1 second, 10 seconds  <b>Display:</b> 8 LED Digits, nonsignificant zero blanking  <b>Rear Panel Input:</b> Sensitivity: 250 mV rms                                    Impedance: &gt; 500Ω                                    Maximum Input: 10V rms                                    Control: Internal/External                                            Switch on rear panel  <b>Ratio:</b> Rear Panel Input, 100 kHz to 10 MHz  <b>External Frequency Standard:</b> Rear Panel Input, 10 MHz  <b>Timebase Output:</b> Frequency: 10 MHz timebase                                    Voltage: 200 mVpp into 50Ω load                                    Control: Active with Rear Panel                                            Internal/External                                            switch in Internal position.  <b>Timebase:</b> Frequency: 10 MHz                            Aging: &lt; 0.3 ppm/month                            Temperature: ±2.5 ppm 0°C to 40°C                            Line Voltage: ±0.5 ppm for 10% line change  <b>Overflow:</b> LED lamp indicator when most significant                            digit overflows</p>	<p><b>Reset:</b> Manual selection of reset occurs when GATE                    TIME switch is between three normal positions.  <b>Package:</b> Rugged, high strength metal case  <b>Operating Temperature:</b> 0°C to 40°C  <b>Power Requirements:</b> 100, 120, 220, 240 V rms (+ 5%,                                    -10%) 48-440 Hz; 30 VA maximum  <b>Weight:</b> Net: 2.2 kg (4.75 lb); Shipping: 2.8 kg (6 lb)  <b>Dimensions:</b> 98 mm H x 160 mm W x 248 mm D (3.5"                            x 6.25" x 9.75")  <b>Rack Mount Kits:</b> 3½" high panels for installation of                            one or two 5380 family counters. Kit is also useful                            with HP 3311A Function Generator, HP 3470 DVM,                            etc.                            HP 10851A Kit for single counter mounting                            HP 10852A Kit for dual counter mounting</p>						
<b>Maximum Input Voltage</b>							
<table border="1"> <tr> <td style="text-align: center;">X1</td> <td>DC to 40 Hz 40 Hz to 100 kHz 100 kHz to 5 MHz  &gt; 5 MHz</td> <td>200 Vmax (dc + peak ac) 200 Vdc + 250 V rms (ac) 200 Vdc + 2.5 x 10<sup>7</sup> V rms (ac)/ freq. (Hz) 200 Vdc + 5 V rms (ac)</td> </tr> <tr> <td style="text-align: center;">X10, X100</td> <td>DC to 40 Hz 40 Hz to 1 MHz 1 MHz to 50 MHz  &gt; 50 MHz</td> <td>200 V (dc + peak ac) 200 Vdc + 250 V rms (ac) 200 Vdc + 2.5 x 10<sup>6</sup> V rms (ac)/ freq. (Hz) 200 Vdc + 5 V rms (ac)</td> </tr> </table>	X1	DC to 40 Hz 40 Hz to 100 kHz 100 kHz to 5 MHz  > 5 MHz	200 Vmax (dc + peak ac) 200 Vdc + 250 V rms (ac) 200 Vdc + 2.5 x 10 <sup>7</sup> V rms (ac)/ freq. (Hz) 200 Vdc + 5 V rms (ac)	X10, X100	DC to 40 Hz 40 Hz to 1 MHz 1 MHz to 50 MHz  > 50 MHz	200 V (dc + peak ac) 200 Vdc + 250 V rms (ac) 200 Vdc + 2.5 x 10 <sup>6</sup> V rms (ac)/ freq. (Hz) 200 Vdc + 5 V rms (ac)	
X1	DC to 40 Hz 40 Hz to 100 kHz 100 kHz to 5 MHz  > 5 MHz	200 Vmax (dc + peak ac) 200 Vdc + 250 V rms (ac) 200 Vdc + 2.5 x 10 <sup>7</sup> V rms (ac)/ freq. (Hz) 200 Vdc + 5 V rms (ac)					
X10, X100	DC to 40 Hz 40 Hz to 1 MHz 1 MHz to 50 MHz  > 50 MHz	200 V (dc + peak ac) 200 Vdc + 250 V rms (ac) 200 Vdc + 2.5 x 10 <sup>6</sup> V rms (ac)/ freq. (Hz) 200 Vdc + 5 V rms (ac)					
<b>OPTION 001</b>							
<p>Temperature Compensated Crystal Oscillator Frequency: 10 MHz          Aging: &lt; 0.1 ppm/month          Temperature: ±1 ppm 0°C to 40°C          Line Voltage: 1 part in 10<sup>7</sup> for 10% change          External input replaced with Oscillator Monitor Output on Option 001</p>							

## SECTION II INSTALLATION

### 2-1. INTRODUCTION

2-2. This section of the manual provides information about unpacking, inspecting, storing, and shipping the frequency counter.

### 2-3. UNPACKING AND INSPECTION

2-4. If the shipping carton is damaged, ask that the carrier's agent be present when the instrument is unpacked. Inspect the instrument for damage such as scratches, dents, broken switches, etc. If the instrument is damaged or fails to meet performance tests, notify the carrier and the nearest Hewlett-Packard Sales and Service Office immediately. Performance check procedures are located in Section IV, and Sales and Service Offices are listed at the back of this manual. Retain the shipping carton and the padding material for the carrier's inspection. The Sales and Service Office will arrange for the repair or replacement of the instrument without waiting for the claim against the carrier to be settled.

### 2-5. STORAGE AND SHIPMENT

2-6. **PACKAGING.** To protect valuable electronic equipment during storage or shipment, always use the best packaging methods available. Your Hewlett-Packard Sales and Service Office can provide packaging material such as that used for original factory packaging. Contract packaging companies in many cities can provide dependable custom packaging on short notice.

2-7. **ENVIRONMENT.** Conditions during storage and shipment should normally be limited as follows:

- a. Maximum altitude: 25,000 ft.
- b. Minimum temperature:  $-40^{\circ}\text{F}$  ( $-40^{\circ}\text{C}$ ).
- c. Maximum temperature:  $+131^{\circ}\text{F}$  ( $+55^{\circ}\text{C}$ ).

### 2-8. LINE VOLTAGE SELECTION

2-9. The counter is supplied from the factory with the **LINE VOLTAGE SELECTOR** switches set for 120-volt, 60 Hz operation. If any other supply voltage is to be used, change the rear-panel switch settings as follows:

- a. Using a small screwdriver, a pencil, or other suitable tool, set the **LINE VOLTAGE SELECTOR** switches on the counter's rear panel to the positions shown next to the desired voltage marking on the rear panel.
- b. Ensure that the correct fuse is installed. Use a Listed, 500 milliamperere, slow-blow fuse for 100-volt or 120-volt operation or a Listed, 250 milliamperere, slow-blow fuse for 220-volt or 240-volt operation.

2-10. If the counter is to be used in the USA with a 240-volt, 60 Hz power source, use a power cord with a Listed connector of the type shown in Figure 2-1.

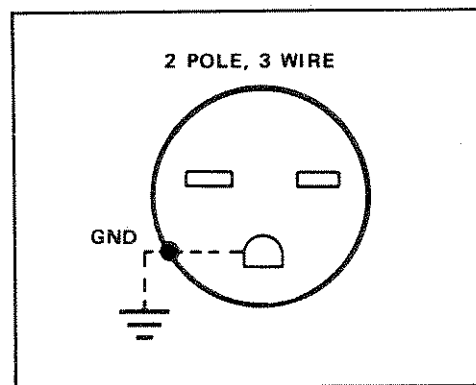

Figure 2-1. Power Cord Connector for 240-Volt Operation

## 2-11. MOUNTING

2-12. The 5382A Frequency Counter is built to be portable, and may be used at any test bench position. Two kits are available for the user who desires to mount his counter on a rack. Kit 10851A permits one counter to be mounted in the center of a rack, while Kit 10852A allows the user to mount two counters, side-by-side on a rack. Figure 2-2 describes how to mount the counter onto the rack provided. Figure 2-3 shows these kits and provides a component parts list.

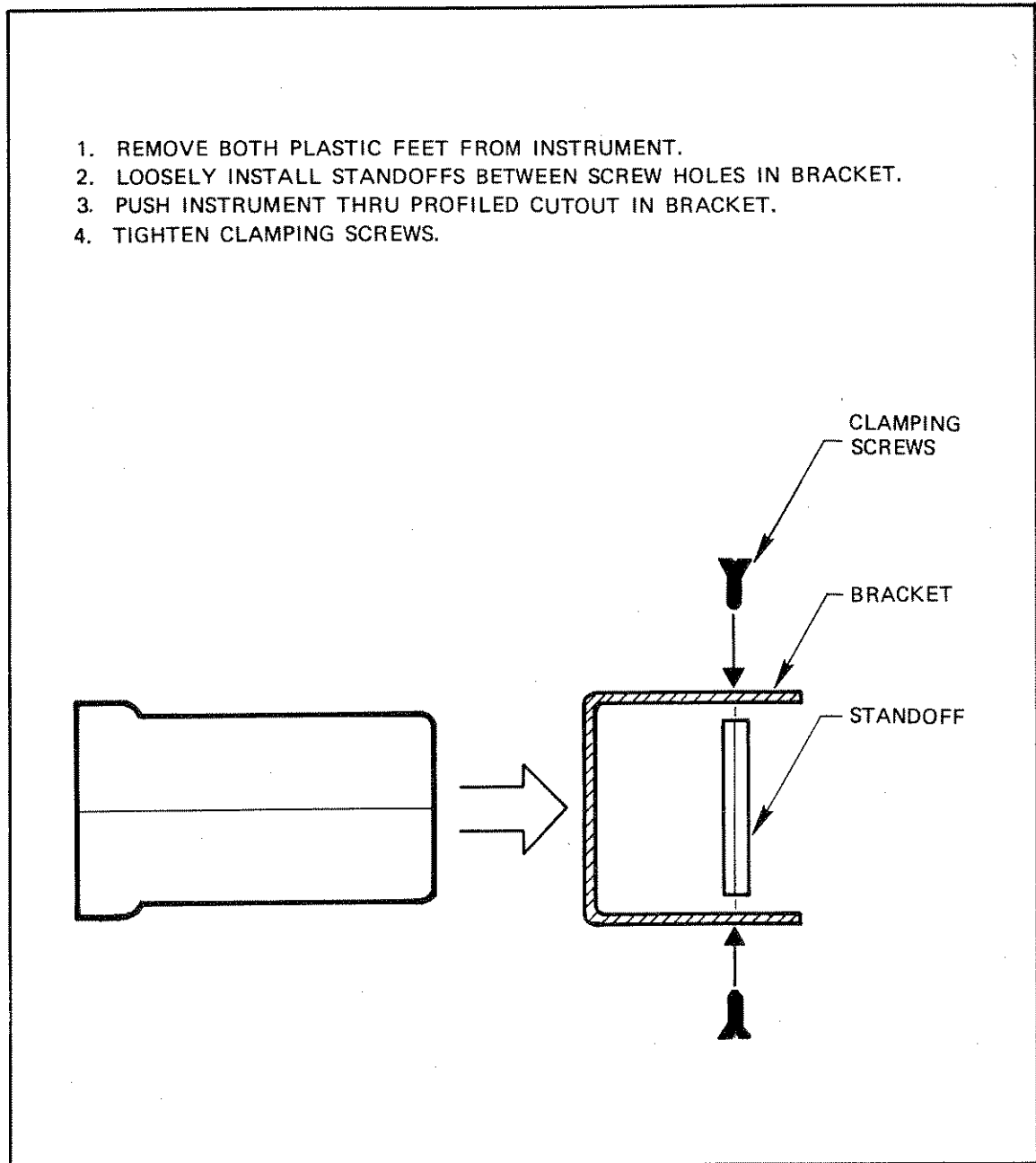

Figure 2-2. Rack Mounting Instructions

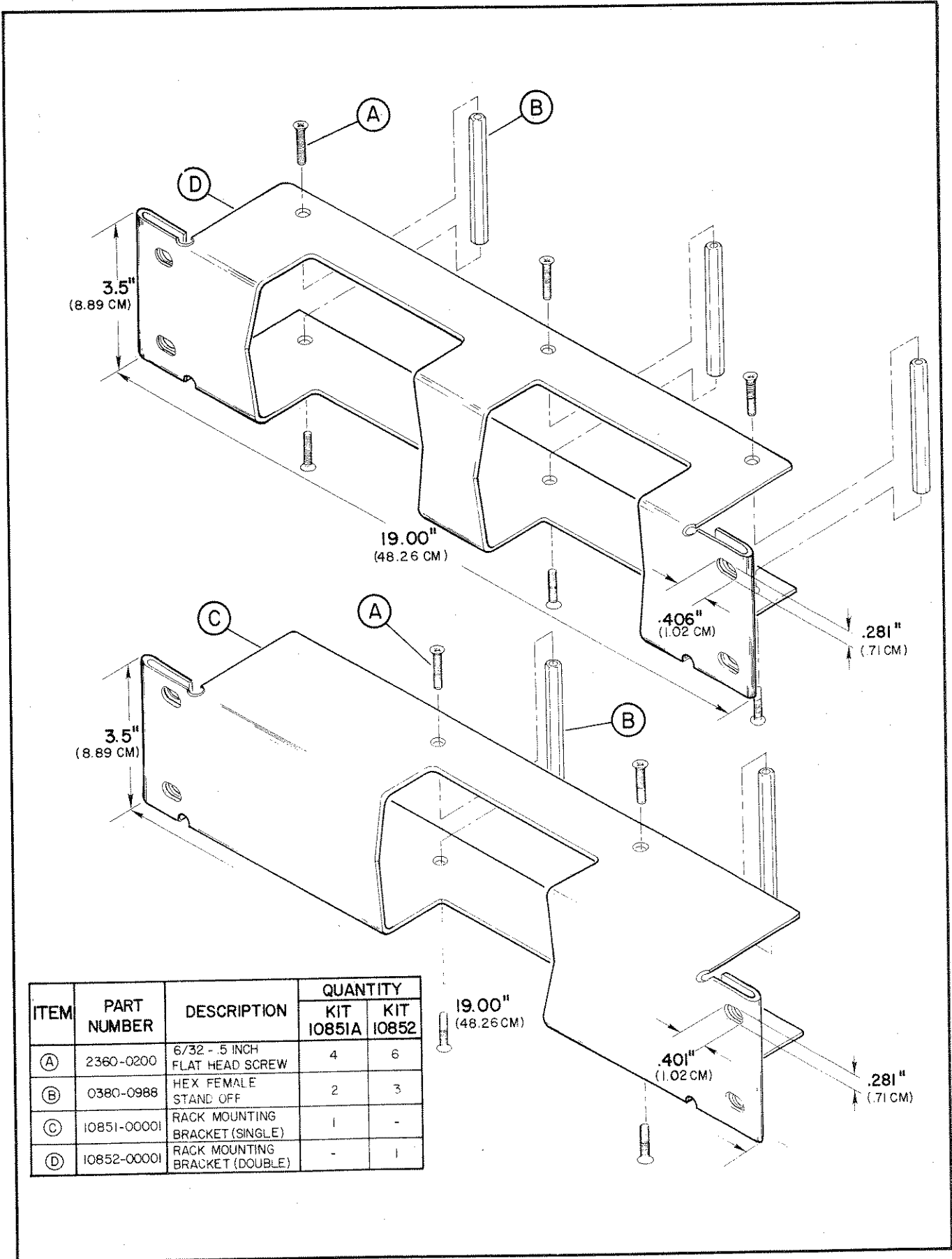

Figure 2-3. Rack Mounting Kit



## SECTION III OPERATION

### 3-1. INTRODUCTION

3-2. This section contains descriptions of the controls, connectors and indicators, measurement techniques, and operator checks.

### 3-3. CONTROLS, CONNECTORS AND INDICATORS

3-4. Figures 3-1 and 3-2 describe the operation of the 5382A controls and the function of the various connectors and indicators. The following paragraphs also provide operating guidelines and brief operator maintenance procedures for the frequency counter.

### 3-5. MEASUREMENT TECHNIQUES

3-6. Noise riding on the input signal can cause erroneous or unstable frequency measurements. Using the internal attenuator, or external attenuators minimizes this problem. Proper selection of the input impedance also allows for stable and accurate frequency measurements. When there is a difference between the signal source impedance and the counter input impedance, ringing may appear on the signal. This ringing could interfere with, and degrade the capability of the counter. Knowledge of the signal source circuit characteristics and selection of compatible input impedances and attenuation permits proper measurements.

### 3-7. Ratio Measurements (Standard Counter Only)

3-8. The standard counter will measure the ratio between the frequencies of two signals if one of the signals is applied to the rear-panel OSCILLATOR-EXT IN connector and the other signal is applied to the front-panel INPUT connector. (The Option 001 counter does not have an external oscillator input connector). Be sure to refer to Table 1-1 for signal level and frequency limits. The displayed value is in units which represent the ratio of one frequency to the other as shown by the following formula:

$$\frac{\text{frequency at front panel INPUT}}{\text{freq at rear panel OSCILLATOR-EXT IN}} = \frac{\text{Display Value}}{X}$$

$$\text{where } X = \begin{array}{l} 10 \text{ if GATE TIME is } .1\text{s} \\ 10^4 \text{ if GATE TIME is } 1\text{s} \\ 10^7 \text{ if GATE TIME is } 10\text{s} \end{array}$$

3-9. Note that in the above formula the term "X" changes by a factor of 1000 ( $10^3$ ) for each change in GATE TIME setting. GATE TIME, itself, changes "X" by a factor of 10, and the decimal point in the display shifts two places ( $10^2$ ) for a total of  $10^5$ . Note, also, that actual measurement time increases as the frequency applied to the OSCILLATOR-EXT IN connector decreases. If the frequency applied to the OSCILLATOR-EXT IN connector is 1 MHz, for example, and GATE TIME is set to 1s, actual measurement time will be 10 seconds.

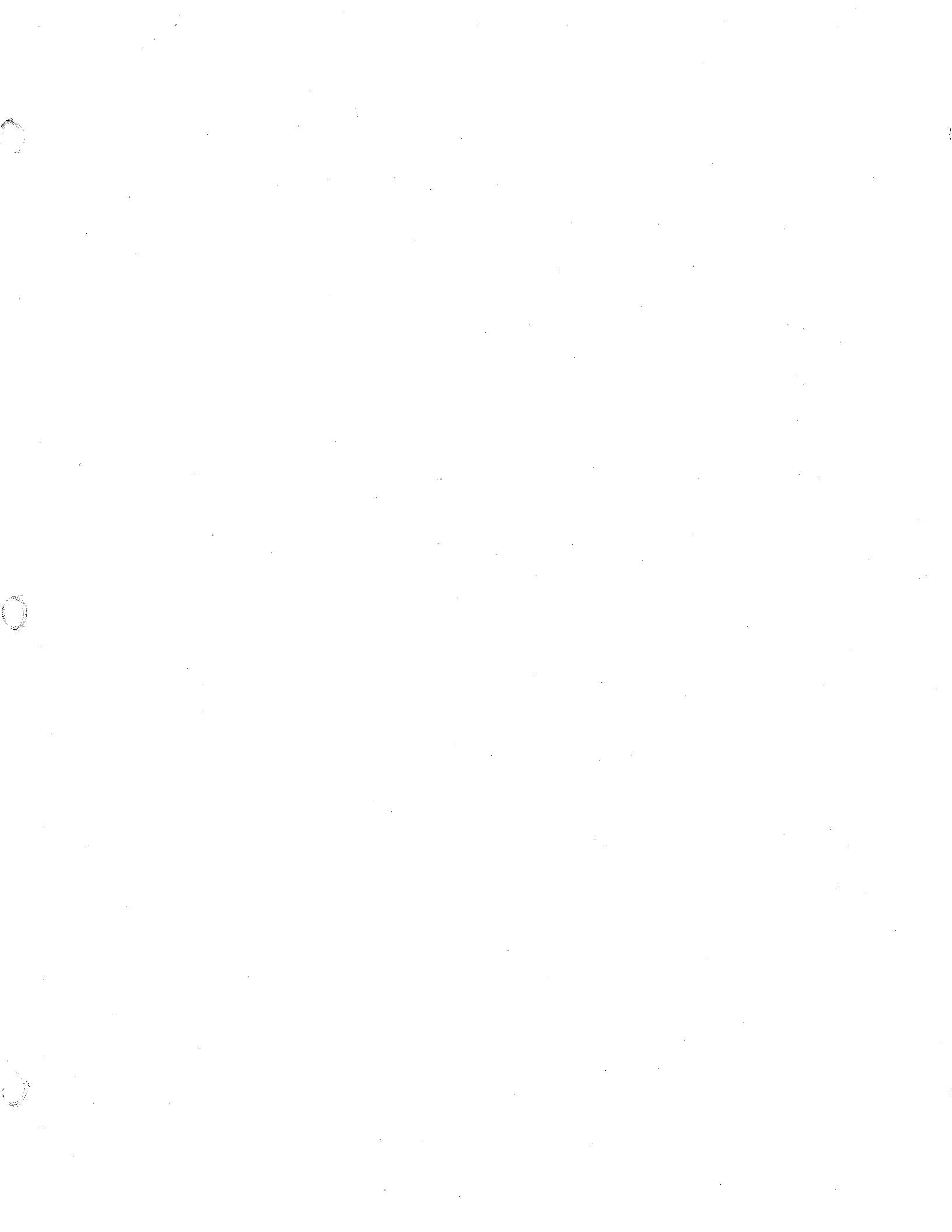

### 3-10. OPERATOR CHECKS

3-11. These quick preliminary checks should be performed by the operator when an instrument failure is suspected:

Problem I. No display digits are illuminated

**CHECK**

- a. Equipment cable plugged in?
- b. Proper line voltage selected on rear panel? (Refer to Paragraph 2-8.)
- c. Rear panel fuse blown? (Refer to Paragraph 2-9.)

Problem II. All display digits are not illuminated.

- a. This is normal. The counter provides a leading zero blanking feature which blanks non-significant display digits. The following displays are correct when a signal is not applied to the counter input:

**GATE TIME Switch  
Position**

**DISPLAY**

.1 S/MHz



1 S/kHz

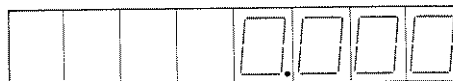

10 S/Hz



3-12. This additional quick and convenient loop-around check is provided to verify normal operation of the instrument:

- a. Set the rear panel INT/EXT switch (exists on the standard counter only) to the INT position.
- b. Set the front panel ATTENUATOR switch to the X1 position.
- c. Connect a coaxial cable between the rear panel OSCILLATOR or MONITOR jack and the front panel INPUT jack.
- d. 10 MHz display ( $\pm 1$  least-significant digit) indicates that the counter is operating normally. The following displays will occur for each position of the GATE TIME switch.

**GATE TIME Switch  
Position**

**DISPLAY**

.1 S/MHz



1 S/kHz

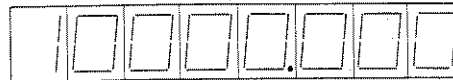

10 S/Hz  
(Overflow  
indicator on)



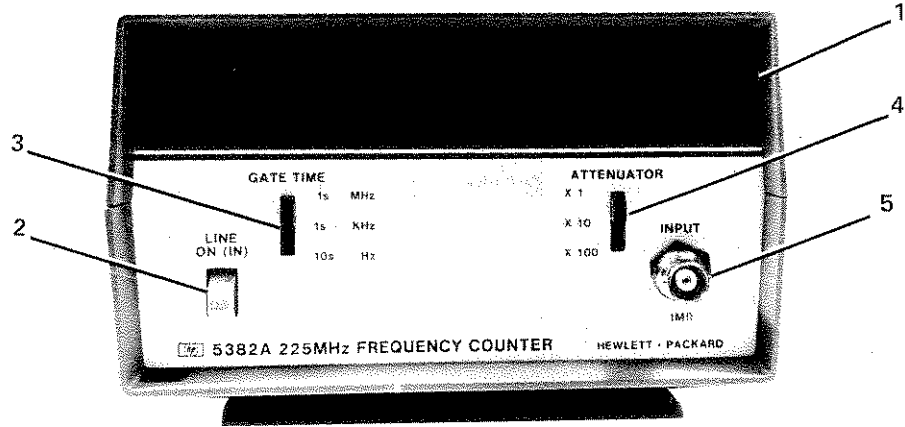

5382-A-1

1. **Display:** Eight digits of LED (light-emitting diode) display are provided on the front panel. A decimal point illuminates in the proper position according to the setting of the GATE TIME switch, and an over-range indicator in the upper, left corner of the display illuminates when the counter overflows.
2. **LINE switch:** The ac power LINE switch is a push-on, push-off type; in the on position, the pushbutton is set further into the front panel.
3. **GATE TIME switch:** Gate time (measurement time) can be set at 0.1-second, 1-second, or 10 seconds with the GATE TIME switch. These positions give resolutions of 10 Hz, 1 Hz, and 0.1 Hz, respectively. If the GATE TIME switch is set to 1s, for example, it will take one second to make a measurement and the measured value will be displayed in 1 Hz increments. Manual resetting of the counter circuits occurs whenever the GATE TIME switch position is changed. Set the GATE TIME switch to provide the best compromise between measurement speed and resolution of the displayed value.
4. **ATTENUATOR switch:** The three-position attenuator switch provides for attenuation of input signals by factors of 10 and 100. The input signal is not attenuated when the switch is set to the "X1" position. The attenuator is used to extend the range of input signal levels that can be measured by the counter and to optimize noise rejection. Maximum sensitivity of the counter ranges from 25 millivolts rms with the attenuator set to "X1" to 2.5 volts rms with the attenuator set to "X100". If the amplitude of a measured signal is unknown or if signal noise causes the display to be unstable, set the ATTENUATOR to "X10" or "X100", then reduce the attenuation, if necessary, until a stable display is observed.

**CAUTION**

**BE SURE THAT THE MAXIMUM ALLOWABLE INPUT VOLTAGES AS GIVEN IN TABLE 1-1, SPECIFICATIONS, ARE NOT EXCEEDED. DAMAGE TO THE COUNTER MAY OTHERWISE RESULT.**

5. **INPUT connector:** Connect the signal to be measured to the BNC-type INPUT jack. Input impedance is 1.0 megohm.

Figure 3-1. Front Panel Operating Controls, Connectors, and Indicators

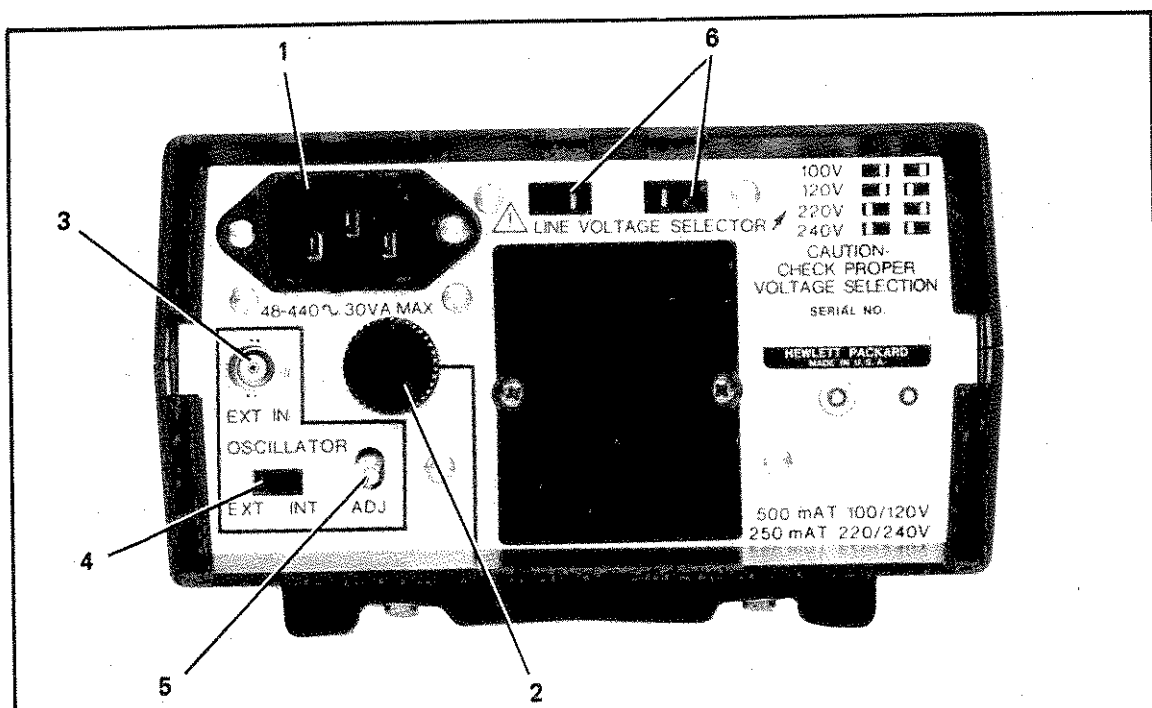

STANDARD INSTRUMENT REAR VIEW

1. Power connector: Connect the source of ac power to the rear-panel power connector.
2. Fuse: A Listed 500 milliampere, slow-blow fuse is required for 100-volt or 120-volt operation; a Listed 250 milliampere, slow-blow fuse is required for 220-volt or 240-volt operation.
3. OSCILLATOR connector: Serves as a monitoring point for the internal time base oscillator, or provides an input path for an external time base oscillator, depending on the EXT/INT switch setting.

**NOTE**

- a. The output is designed to drive a 50Ω load.
- b. The internal time base oscillator output may be connected to the front panel input jack (with INPUT switch in the X1 position) to provide a convenient counter self-check operation.

4. EXT/INT switch: Selects the function of the OSCILLATOR connector:

Switch Position	OSCILLATOR Connector Function
EXT	Provides a nominal 50Ω input impedance path for an external 10 MHz time base or ratio input.
INT	Monitors the internal timebase oscillator. An optimum signal is obtained when the output drives a 50Ω load (>200 mV peak-to-peak).

5. OSCILLATOR-ADJ control: The ADJ control is used to set the frequency of the internal time base oscillator. Refer to the *Adjustments* paragraphs in Section IV for information.
6. LINE VOLTAGE SELECTOR switches: Set the switches to correspond with the voltage of the ac power source. (Refer to Paragraph 2-8 for instructions.)

Figure 3-2. Rear-Panel Operating Controls and Connectors

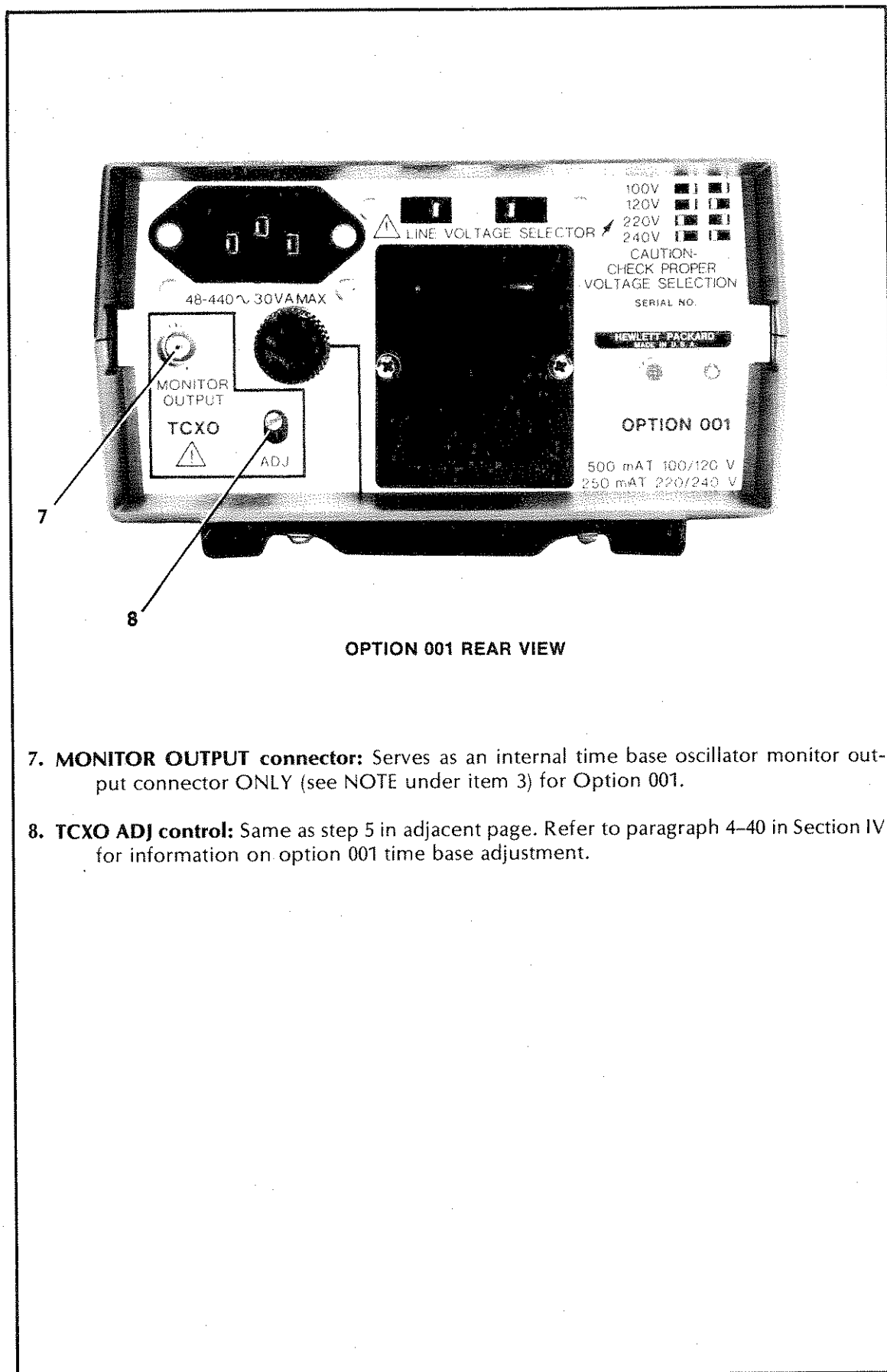

OPTION 001 REAR VIEW

- 7. **MONITOR OUTPUT connector:** Serves as an internal time base oscillator monitor output connector ONLY (see NOTE under item 3) for Option 001.
- 8. **TCXO ADJ control:** Same as step 5 in adjacent page. Refer to paragraph 4-40 in Section IV for information on option 001 time base adjustment.

Figure 3-2. Rear-Panel Operating Controls and Connectors (Cont'd)